



**Quick Installation Guide**

For articles: XC...L, XC...F, XC...FM

**EAC**

61.962\_02









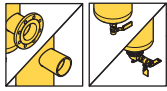
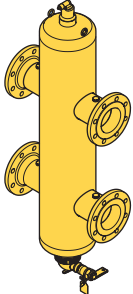

 0-10 bar

 0-110 °C

Acc. PED (2014/68/EU) §4.3







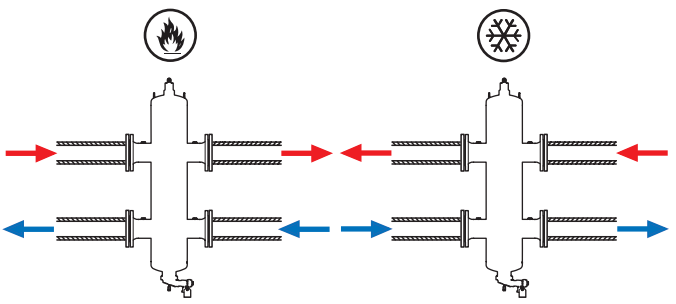

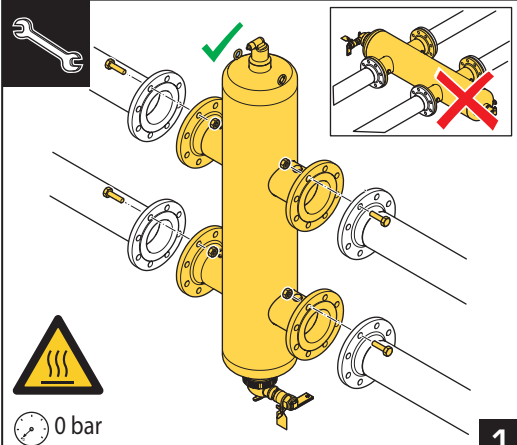



< 50% glycol







 0 bar

1

 Pmax = 15 bar

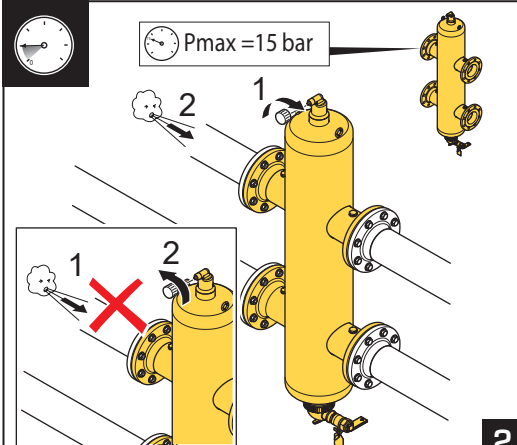

2

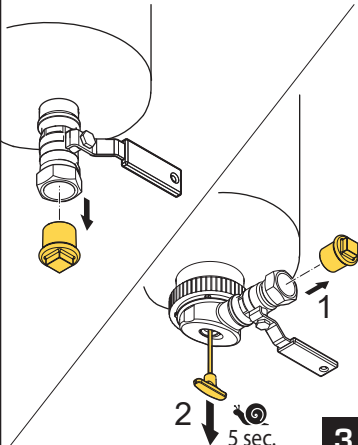

2 ↓ 5 sec.

3

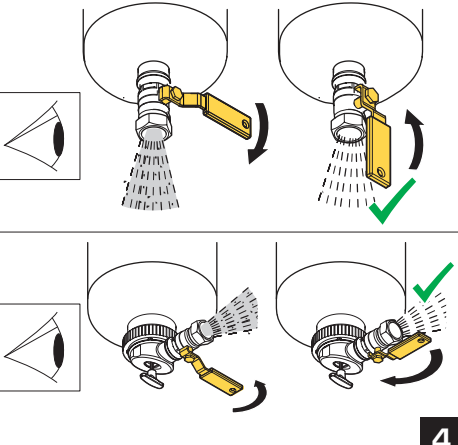

4

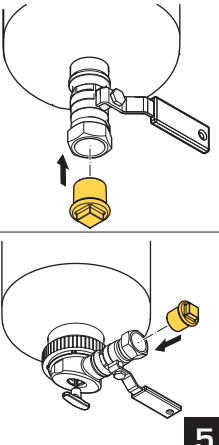

5